

Saturn[®]

ST-TWM1014

**UNIVERSAL WALL MOUNT FOR
LCD/LED TV**

LCD/LED

LCD / LED



GB

UNIVERSAL WALL MOUNT FOR LCD/LED TV

Dear Buyer!
We congratulate you on having bought the device under trade name "Saturn". We are sure that our devices will become faithful and reliable assistance in your housekeeping.

Avoid extreme temperature changes. Rapid temperature change (e.g. when the unit is moved from freezing temperature to a warm room) may cause condensation inside the unit and a malfunction when it is switched on. In this case leave the unit at room temperature for at least 1.5 hours before switching it on. If the unit has been in transit, leave it indoors for at least 1.5 hours before starting operation. Read all instructions before using.

Safeguard measures

This product contains small items that could be a choking hazard if swallowed. Keep these items away from young children.

- Make Sure these instructions are read and completely understood before attempting installation. If you are unsure of any part of this installation, please contact a professional installer for assistance.
- The wall or mounting surface must be capable of supporting the combined weight of the mount and the display, otherwise the structure must be reinforced.
- Safety gear and proper tools must be used. A minimum of two people are required for this installation. Failure to use safety gear can result in property damage, serious injury or death.
- Please check joint parts every two months, making sure the screws are loosened or not.

This product was designed to be installed on wood stud walls and solid concrete walls. Before installing, make sure the wall will support the combined load of the equipment and hardware. Never exceed the maximum load capacity 40 kg or else it may result in product failure or personal injury.

Note: this product is intended for indoor use only. Use of this product outdoors could lead to product failure or personal injury.

Service life – 2 years.

Installation guide

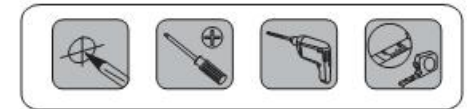
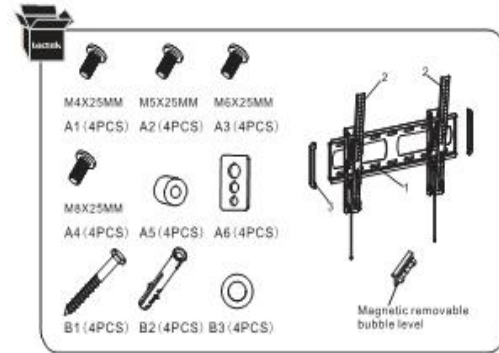

Step 1

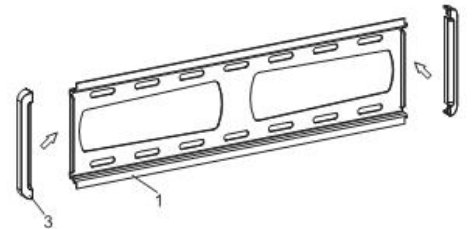

Step 2- Solid concrete mounting

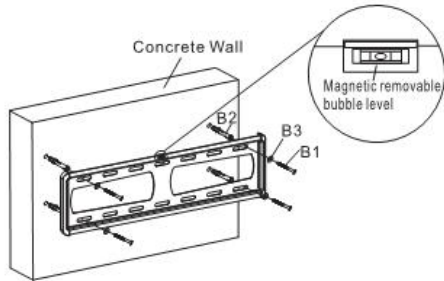
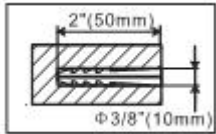
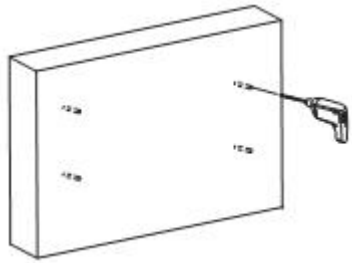

Step 2-
Wood Stud Mounting

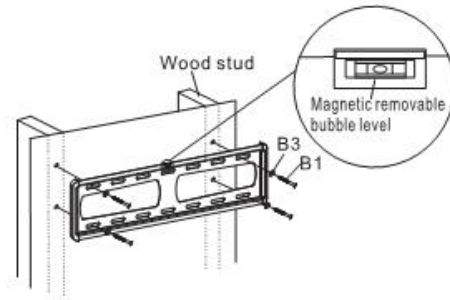
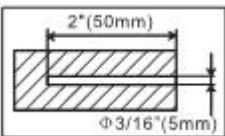
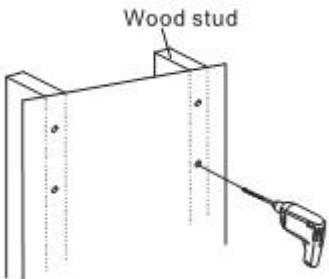

Step 3-
Attaching Brackets To Screen
For TVs with a flat back

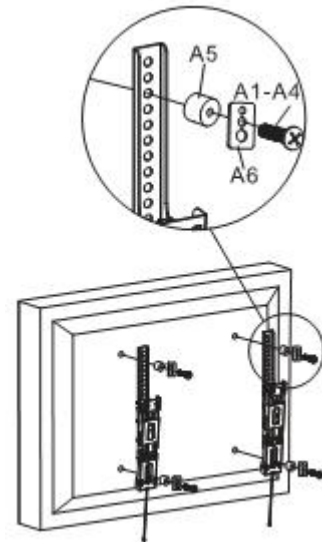

Step 3-
For TVs with a curved back or obstruction

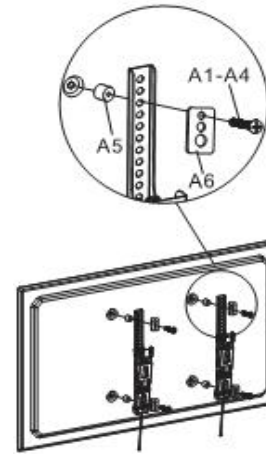
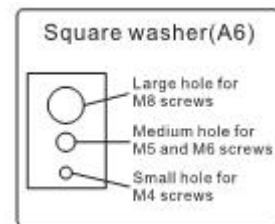

Step 4
Hang the TV onto the wall plate

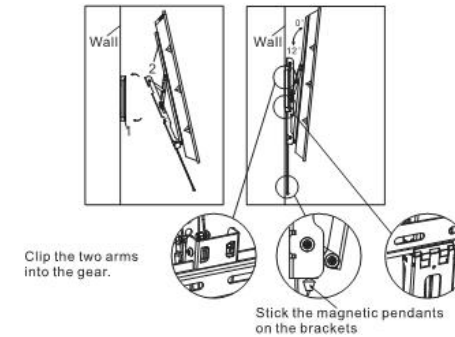

(1) Press the brackets after you put them on the wall plate, then they would be locked with wall plate.

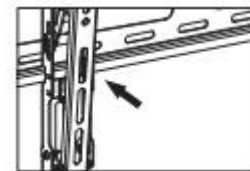

(2) Install the cable easily after you unlock the brackets from wall plate.

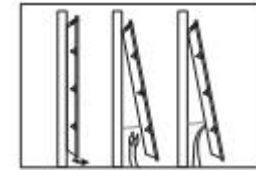

(3) Pull down two strings together to unlock the brackets from the wall plate, then you can take brackets down.

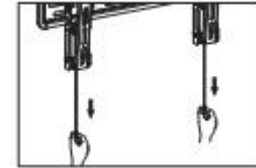

Set
UNIVERSAL WALL MOUNT
FOR LCD/LED TV
INSTRUCTION MANUAL
WITH WARRANTY BOOK
PACKAGE

	1
	1
	1

ENVIRONMENT FRIENDLY DISPOSAL
You can help protect the environment!
Please remember to respect the local regulations: hand in the non-working electrical equipment to an appropriate waste disposal center.
The manufacturer reserves the right to change the specification.

RU

LCD/LED

"Saturn".

1,5

1,5

2 ()

2 ()

- 2

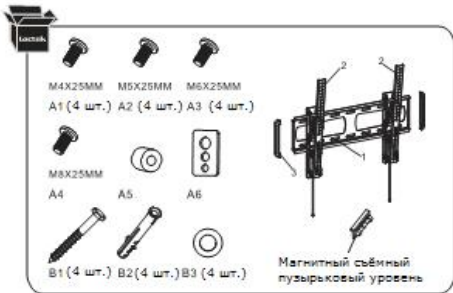

1

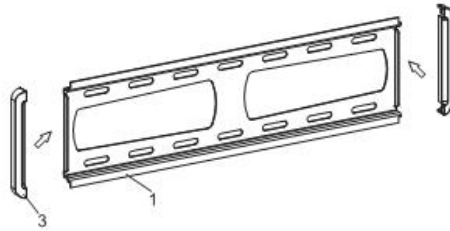

2-

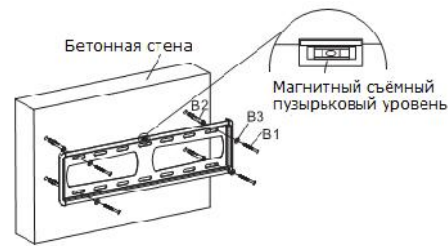
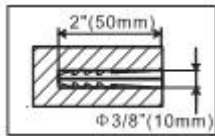
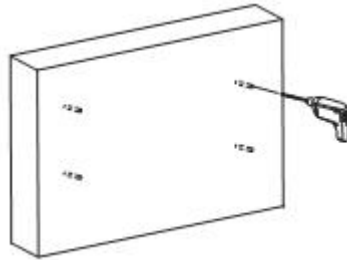

2-

6

Деревянный массив

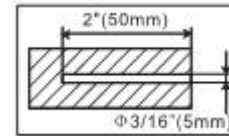
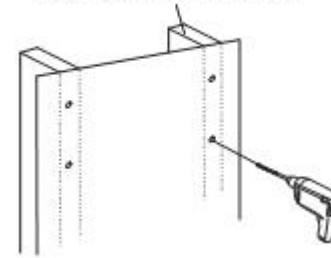

Деревянный массив

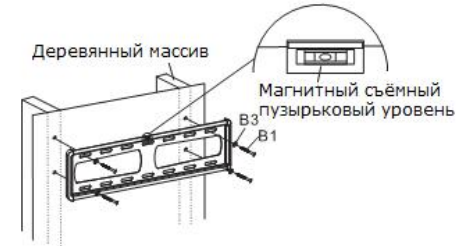

3-

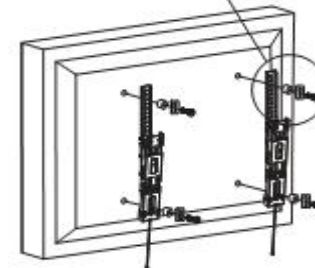
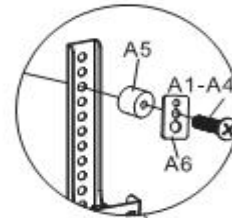

3-

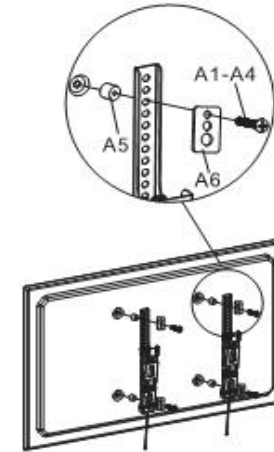
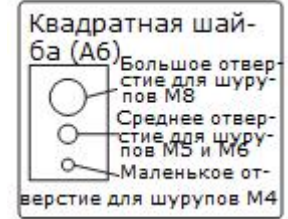

4

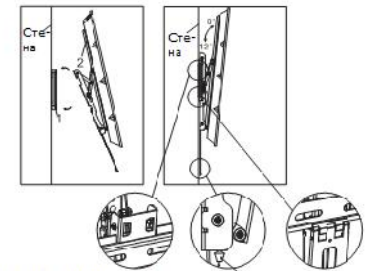

Зафиксируйте две направляющие в настенной панели.

Прикрепите магнитные подвески на кронштейн.

(1)

7

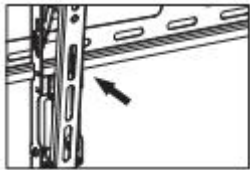

(2)

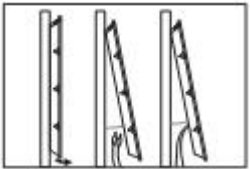

(3)

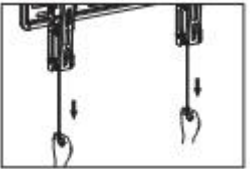

LCD/LED1
1
1

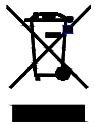

-2



LCD / LED

"Saturn".

1,5

1,5

2 ()

2 ()

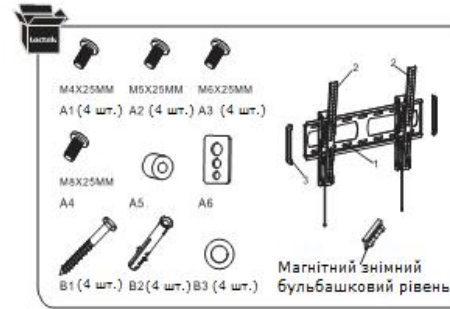

1

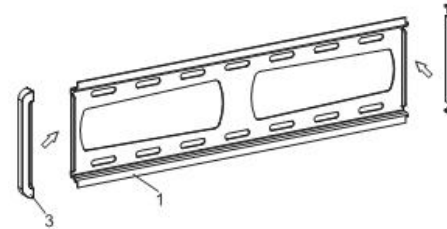

2-

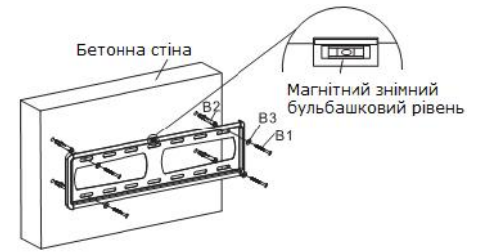
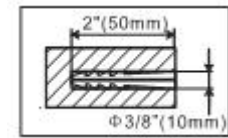
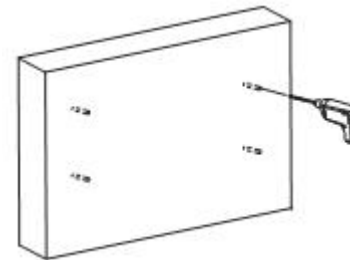

2-

Дерев'яний масив

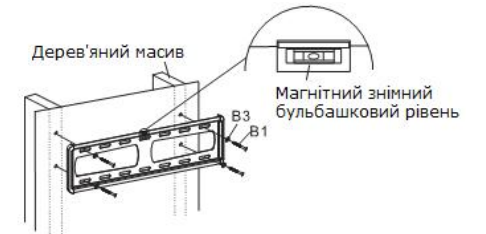
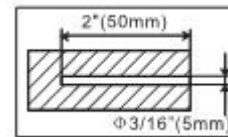
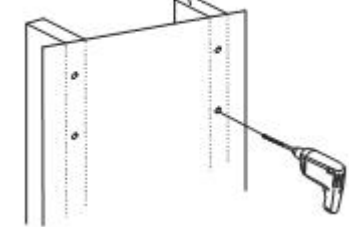

3-

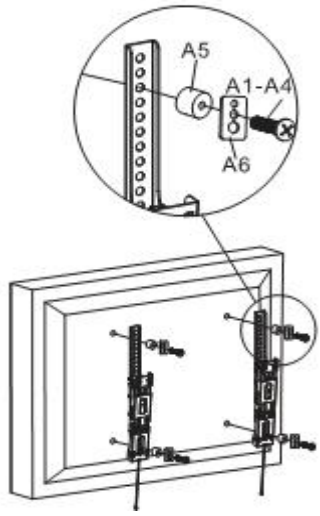

3-

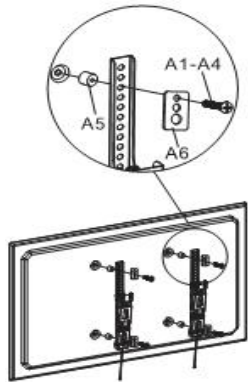

4

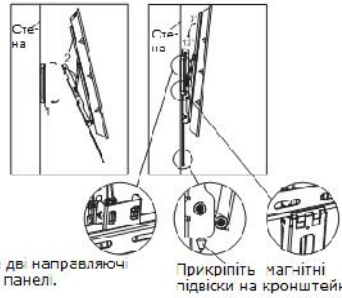

Зафіксуйте дві направляючі в настінній панелі.

Прикріпіть магнітні підвіски на кронштейн.

(1)

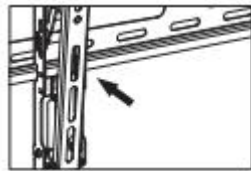

(2)

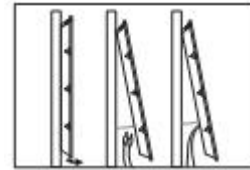

(3)

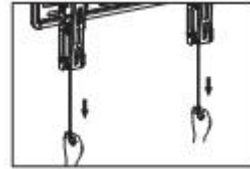

LCD / LED

.....1
3
.....1
.....1



Saturn®

INTERNATIONAL MANUFACTURER'S WARRANTY

MEZINÁRODNÍ ZÁRUKA

GB

INTERNATIONAL MANUFACTURER'S WARRANTY

The Warranty is provided for the period of 2 years or more if the Law on User Right of the country where the appliance was bought provides for a greater minimum warranty period.

All terms of warranty comply with to the Law on Protection of the Consumer Rights and are governed by the legislation of the country where the product was bought. The warranty and free of charge repair are provided in any country where the product is delivered to by Saturn Home Appliances or authorized representative thereof, and where no restriction of import or other legal provisions interfere with rendering of warranty services and free of charge repair.

Cases uncovered by the warranty and free of charge repair:

1. Guarantee coupon is filled in improperly.
2. The product has become inoperable because of the Buyer's nonobservance of the service regulations indicated in the instruction.
3. The product was used for professional, commercial or industrial purposes (except for the models, specially intended for this purpose that is indicated in the instruction).
4. The product has external mechanical damage or damage caused by penetration of the liquid inside, dust, insects and other foreign objects.
5. The product has damages caused by non-observance of the rules of power supply from batteries, mains or accumulators.
6. The product was exposed to opening, repair or modification of design by the persons, unauthorized to repair; independent cleaning of internal mechanisms etc. was made.
7. The product has natural wear of parts with limited service life, expendables etc.
8. The product has deposits of scale inside or outside of fire-bar elements, irrespective of used water quality.
9. The product has damages caused by effect of high (low) temperatures or fire on non-heat resistant parts of the product.
10. The product has damages of accessories and nozzles which are included into the complete set of product shipment (filters, grids, bags, flasks, cups, covers, knives, sealing rings, graters, disks, plates, tubes, hoses, brushes, and also power cords, headphone cords etc.).

On the warranty service and repair, please contact the authorized service centers of "Saturn Home Appliances".

158		8-937-730-66-03			+		+	+
		8-904-404-14-55					+	+
C 12/15	«Master»	8-928-126-63-66		+		+		
77- .65	«	8(937) 717-93-36		+		+		
.65	«	8(8172) 70-03-45, 8(8172) 54-21-54		+		+	+	+
.1	«	8(8172) 52-72-51		+		+		
.46	" "	8(473) 260-09-08, 8(473) 240-57-73		+		+	+	
140/1	-	8(87951) 6-47-93, 8-928-654-28-01				+		
.48	«	8-962-655-20-00		+	+	+	+	+
.68	«	8(8313) 21-14-14		+		+		

.54	«	8(8313) 20-93-00, 8(8313) 20-92-94				+		
.63	" - "	8(84235) 2-86-59, 8(84235) 9-14-64			+		+	+
.84	« - »	8(86132) 2-11-71, 8(86132) 3-66-02			+	+	+	+
.64	" - "	8(343)240-26-60			+		+	
.16	/ " - "	8(343) 201-51-41, 8(343)347-76-83			+	+	+	+
47	«	8(47467) 4-12-08, 8(47467) 4-33-17			+		+	
.45/6	« - »	8(4932) 335185, 8(4932) 335236			+	+	+	+
.4	« - »	8(3412) 3079-79, 8(3412)30-83-07			+		+	+
.76	« - »	8(3412) 78-76-85, 8(3412) 78-06-64			+		+	+
7/1, 301, 307	« - »	8(3412) 44-60-40, 8(3412) 44-60-67				+		

« 7 (« »)	« 26» -	8(86545) 2-74-74		+				
« 24	« - »	8(8362) 24-11-24, 8(8362) 25-55-40	+	+	+	+		
« 20	« »	8(39520) 65-04-95, 8(39520) 93-16-56	+		+	+		
« 24	" "	8(3952) 42-55-76, 8(3952) 78-15-83	+		+			
« 38	« »	8(843) 248-71-17, 8(843) 258-85-65	+		+			
« 25, 47	« - »	8 (4842) 54-82-22, 8 (4842) 54-83-33	+	+	+	+	+	
33	-	8(3439) 39-95-20, 8(34399)34-74-40	+	+	+	+	+	
53/2	-	8(3842) 35-39-67	+			+		
« 42	« - »	8(8332) 56-25-95, 8(8332) 54-70-77	+		+	+		
« 9	-	8-988-548-24-36	+	+	+			
« 1	« - »	8(4942) 300107,	+		+	+	+	

5	»	8(4942) 300107						
« 2,	-	8(86142)4-43-59	+	+	+	+	+	
« 3	-	8(861) 267-50-88	+	+	+	+	+	
103, « 55	« - »	8(861) 222-64-13, 8(861) 222-85-55, 8-905-408-08-38	+	+	+	+	+	
« 42/2	-	8-918-041-31-04, 8(86131) 71-2-72			+			+
« 116	-	8(86164) 7-01-22			+			
« 57	" - "	8(86145) 3-78-74	+	+	+	+	+	
« 25	« - »	8(86164) 65-4-95, 8-918-355-81-70	+	+			+	+
« 1	-	8(86153) 4-16-70			+			
« 168	" "	8(86151) 4-33-54, 8-918-464-00-86	+	+			+	+
« 1	« »	8(3912) 93-54-33, 8(3912) 94-52-82	+	+	+	+	+	

36-	« +»	8 (4712) 50-85-90, 8 (4712) 35-04-91	+	+	+	+	
	« »	8 (86169) 7-39-99, 8(86169) 7-24-96	+	+	+	+	+
.66	" "	8(4742) 33-45-65, 8(4742) 33-45-95	+	+	+	+	+
.29	« »	8 (8772) 52-36-90	+	+	+	+	
25	« - »	8 (8772) 55-62-38		+			+
.20	« - »	8(8722) 93-30-73	+	+	+	+	+
11	« »	8(86385) 2-33-26 8-960-458-07-11	+	+		+	+
.16, .9	« - »	8 (499) 340-29-89, 8 (499) 733-25-00		+			
1534	« - »	8(499) 717-82-07, 8(499) 717-82-12	+		+	+	+
.3 (. .)	« »	8(495) 721-30-70, 8(499) 168-05-19, 8(499) 168-47-15	+		+	+	+
.20 (30/05)	« »	8(8552) 359002, 8(8522) 359042	+	+	+		

24	" - "	8(8662) 42-04-30 8(8662) 42-12-21	+		+	+	
55	« - »	8(86554) 5-59-77, 8(86554) 3-67-57	+	+	+	+	+
.9 (. « »)	« »	8(8555) 48-08-80, 8-917-906-60-06	+		+	+	+
.21	« - »	8(831) 229-63-66, 8(831) 229-60-87	+		+	+	
.18	« - »	8(831) 46-18-848		+			+
.6	« - »	8(831) 46-18-848		+			+
.18	« - »	8 (3843) 20-31-33	+		+	+	+
.14	« - »	8(8617) 63-11-15, 8(8617) 63-03-95	+	+	+	+	+
17	" - "	8(383)274-99-33, 8(383) 274-99-45	+		+		
24		8(86369) 3-74-75, 8-928-609-35-85	+	+	+		
4	. . .	8 (3532) 36-87-94	+			+	+

16	« - »	8(3532) 77-67-64, 8(3532) 78-15-82	+	+	+	+	+
130	" - "	8(3812)36-42-02	+		+	+	+
2	« - +»	8(3537) 33-84-43, 8(3537) 35-13-18	+	+	+	+	+
2	« »	8(8412) 26-09-60, 8(8412) 26-12-29	+		+	+	+
3	« - »	8 (342) 221-40-99	+	+	+	+	+
11	« - »	8(8142) 78-06-93, 8(8142) 70-65-48	+		+		
11	« - »	8 (8112)-53-86-30, 8 (8112)-53-86-50	+		+		
12		8(793) 31-84-16	+	+	+	+	+
5-13	" "	8(8793) 98-70-11	+	+	+	+	+
148	- -	8(47396) 48-911	+	+	+	+	+
37	« - »	8(863) 250-47-77	+		+		

50-1/52, 55	« »	8 (863) 21-92-112, 8-800-100-51-52	+	+	+	+	+
11 /17		8-906-453-35-81	+		+		
12	« - »	8(4855) 22-04-77, 8(4855) 25-38-60	+	+	+	+	+
14	" "	8(86370) 2-19-50	+	+	+	+	+
12	" - "	8(4855) 22-04-77, 8(4855) 25-38-60	+	+	+	+	+
21	« - »	8(4855) 24-31-21	+	+	+	+	+
1	« - »	8(4912) 76-88-01, 8(4912) 40-30-30	+	+	+	+	+
42" "	« - »	8(4912) 41-33-02,	+	+	+	+	+
52, 8, 9		8(846) 931-85-46	+	+	+	+	
63	" - "	8(846) 379-54-54	+	+	+	+	+
e 197	« - XXI»	8(812) 600-11-97	+	+	+	+	

е 41,	« - »	8(812) 325-36-56, 8(812) 325-36-57	+		+	+		
е .11, 36	« -95»	8(812) 822-18-00, 8(812) 320-06-61	+					
	« - »	8(8342) 23-05-91, 8(8342) 47-48-59	+	+	+			
3-	« - »	8(8452) 35-11-80, 8(8452) 55-43-63	+	+	+	+	+	+
		8-951-522-38-11	+	+	+	+	+	+
253	« - »	8(496) 547-04-95, 8(496) 549-32-79	+	+		+	+	
	« »	8 (8622)55-51-19, 8 (8622) 55-01-08	+			+	+	
.50 .8/1	« »	8(8652) 74-01-91	+	+	+			
63	« »	8(8652) 24-30-14, 8(8652) 23-31-81	+	+	+	+	+	+
15 .21	« - »	8(8652)95-53-68, (8652)95-61-90			+			
	« - »	8 (4725) 24-62-27, 8 (4725) 24-73-49	+	+	+			

.158	« - »	8(3473) 20-12-13, 8(3473) 20-27-70	+		+	+	+	+
	« »	8(8212) 22-95-29, 8(8212) 29-12-20	+	+		+	+	+
137	« -2000»	8(4752) 56-19-42, 8(4752) 56-19-44	+	+	+	+	+	+
88/15	-	8-910-834-80-35, 8-952-065-89-10	+			+		
.24/2	- -	8(86130) 4-86-59, 8-918-147-02-03	+	+			+	+
.2/2	" - "	8(86196) 7-20-53	+	+	+	+	+	+
.48	« +»	8(8482) 22-72-41, 8(8482) 22-71-85, 8(8482) 61-65-64	+	+	+	+	+	+
.58	« -2»	8(3822) 56-23-35, 8(3822) 48-08-80	+			+		
.137	« - »	8(4872) 31-12-57	+	+	+	+	+	+
.55	"	8(3452) 47-35-69	+			+	+	+
.28	« »	8(3012) 21-89-63	+			+	+	+

18, 2	« »	8(8422) 31-00-00	+	+	+	+	+
.16/7	« - »	8(8422)73-44-22, 8(8422) 73-29-19	+	+		+	+
378	« - »	8(87875) 7-44-82	+	+	+		
.148	« - »	8(3472) 77-12-62	+		+		
.153, .42, .7	« »	8(347) 279-90-70, 8(347) 241-62-02					+
15	" " -	8(86391) 2-18-06	+		+		
36	« - »	8(8352) 62-30-97, 8(4942) 63-20-98	+		+		
.102 ()	-	8(351) 772-72-05, 8(351) 772-73-66, 8(351) 772-69-01	+	+	+	+	+
.8 ()	-	8(351) 239-39-34, 8(351) 239-39-35	+	+	+	+	+

.18	« »	8(8202) 54-31-88	+		+	+	+
.340" "	« - »	8(8782) 27-30-60, 8(8782) 27-70-77	+	+	+	+	+
.48, 11	" . ."	8(8782)25-04-66, 8(8782)25-19-15	+	+	+	+	+
.1	-	8-904-345-83-18	+	+	+	+	+
.3- .21	« - »	8 (84722) 9-52-07, 8-937-469-52-07	+	+	+	+	+
.57	« - »	8(8453) 55-80-89, 8-964-848-45-06	+		+	+	+
.12	« - »	8 (4852) 25-94-83	+		+		

2

«Saturn Home Appliances»

- 1.
- 2.
- 3.
- 4.
- 5.
- 6.
- 7.
- 8.
- 9.
- 10.

«Saturn Home Appliances».

				/	-	-
1	,36	Hi-Fi	(064) 424-89-50	+	+	+
2	.14		(065)632 21 83, 050-904-57-17	+	+	+
3	,66		062744-60- 38(39)	+	+	+
4	,49		(04563) 633-19	-	+	-
5	.50- ,82		(045) 63-68-413	+	+	+
6	,57		(041) 43-406-36	+	+	-
7	,43	" "	(0314 1) 43-432	+	+	+
8	,3, .8		(044) 332-01-67	+	+	+
9	,42		(0432) 46-50-01	+	+	-
10	,61		(0432) 61-95-73	+	+	+
11	,16		(0432) 464393; (0432) 468213	+	+	+
12	,3		(0432) 64-24- 57, (0432) 64-26-22	+	+	+
13	,1		(0432) 509-191, 579-191	+	+	+
14	,68, 1 , .420		(0562) 337-574	+	+	+
15	17 .130		(056) 778-63-25 (28)	+	+	+
16	,59		(0562) 35-04-09	+	+	+

17	,118		(0562) 67-60-44	+	+	+
18	,41		(056) 790-04-60	+	+	+
19	,9		(068) 851-33-33	+	+	+
20	188		(062) 3450607 0953204451	+	+	+
21	,129		(062) 349-26-81	+	+	+
22	,1		(062) 3027569 (066)5082652	+	+	+
23	,8	" "	(0412) 471-568	+	+	-
24	,4 .222		(067) 410 2198	+	+	+
25	24	C	(0412) 47-07- 42, 42-11-53	+	+	-
26	,50		(061) 220-97-65 (64)	+	+	+
27	,175		(061) 701-65-96	+	+	+
28	,83		(061)212-03-03	+	+	+
29	,75		066-085-75-39	+	+	+
30	19		(0342)559-525, 750-777	+	+	+
31	,14		(0342) 754737	+	+	-
32	,9		096-729- 4038,067-484- 9888	+	+	+
33	,76		(04597) 57393	+	+	-

34	,161		(04736) 629-49	+	+	+
35	1		(044) 591-11-90	+	+	+
36	,1	" "	(044) 4269198	+	+	-
37	,9 .57		(044) 369-5001 (063) 486-6999	+	+	+
38	,10		(06272) 2-62- 23, (050) 279-68-16	+	+	+
39	,1	" "	(0522) 301-456	+	+	+
40	,2		(0522) 35-79-23	+	+	+
41	,98		(0522) 270- 345,349-585	+	+	+
42	,13		(097) 264-21- 67, 776-67-70	+	+	+
43	,3 .5	" "	(04142) 5-05-04	+	+	+
44	,15-106		(06264) 5-93-89	+	+	+
45	,7		(050) 526-06-68	+	+	+
46	,44 .1		(05366) 39-192	+	+	-
47	,42		(056) 401-33- 56, 404-00-80, 474-61-03	+	+	+
48	,9		(056) 4092302 03	+	+	+
49	,64/7		(0564) 40-07-79	+	+	+
50	,73	" "	(056) 440-07-64	+	+	+
51	,81		(050) 214-91- 73; (066) 017- 02-03	+	+	+

52	' ,49 -	-	(0642) 505-783	+	+	+
53	,50		(0642)50-57-83	+	+	+
54	' ,96 -		(0642) 494-217, 33-11-86	+	+	+
55	' ,1	-	(0332)290752	+	+	+
56	' ,15 -		(032) 244-53-44	+	+	+
57	' 35 '	" -	(032) 2973631	+	+	+
58	' ,2		(032) 247-14-99	+	+	+
59	' ,116	" -	(032) 245-80-52	+	+	-
60	' ,28		(032) 239-51-52 (032) 239-55- 77,295-50-28, 295-50-29	+	+	+
61	' ,9	" "	032-267-63-26	+	+	-
62	' ,242		(062)322-55-50	+	+	+
63	' ,2	-	04337- 64847;0432- 468213	+	+	+
64	' ,24/1		(099) 262-11-18	+	+	+
65	' ,46		(03131)37-337, 37-336	+	+	-
66	' ,50 ,32/18		(0629) 41-06-50	+	+	+
67	' ,227	" -	(0629) 473-000	+	+	+
68	' ,33,	" "	(0512) 580-555	+	+	+

69	' ,49	" "	0512-58-21-80	+	+	+
70	' ,2		(0512) 58-06-47	+	+	+
71	' ,62	-	(05662) 22-488, (097) 402-71-95	+	+	-
72	' ,97, ,2	" , - "	(05662) 4-15-03	+	+	-
73	' ,38		(055) 497-26-17	+	+	-
74	' ,38	" "	(041)4152010	+	+	-
75	' ,66 (,2)		048-7317704; 7317703;	+	+	+
76	' ,90		(048) 700 17 37	+	+	+
77	' ,55	" "	(048) 715-10- 25, (0482) 39- 06-18	+	+	+
78	' ,67	" "	8(05632) 6-15- 54, (05632) 6- 23-42	+	+	-
79	' ,26		050-013-72-17, 0532-509889	+	+	+
80	' ,14		(0532) 69-42-62	+	+	+
81	' ,21	-	(0532) 69-09-46 (093)562-81-25	+	+	+
82	' ,66	-	(0532)615-621	+	+	+
83	' ,371	-	(04637)53-982 (093)753-38-28	+	+	+
84	' ,101/1		(046) 3738595	+	+	+
85	' ,12	-	(0362) 26-67- 53,26-65-85	+	+	-

86	, , 26		(0692) 55-56-43, 45-36-99	+	+	+
87	, 72	-	(0652)-69-07-78	+	+	+
88	, 17/1	" - "	(0652) 522-771	+	+	+
89	, 32	-	(04733)-46-182	+	+	-
90	15 (, .)		(06444)40289	+	+	+
91	, 171 /10	-	(245) 53-136	+	+	+
92	, 19		(0542) 705-296	+	+	-
93	, 17	SLT- Service	(0542) 78-10-13	+	+	+
94	, 2	" "	(0352) 26-30-13, 23-17-97	+	+	-
95	, 1/24	" "	(047) 44-46-614,(047) 44-46-134	+	+	+
96	, 101		(0312) 661-297	+	+	+
97	, 12		(057) 717-13-39, 702-16-20	+	+	+
98	, 3		(057) 734-97-24, 712-51-81	+	+	-
99	18 (, - 42)	" "	(096) 595-37-46	+	+	+
100	, 1		(03142) 42-258	+	+	+
101	, 5	-	(0552) 29-60-42	+	+	+
102	, 28		(0552) 43-40-33	+	+	+
103	, 35		(0552) 420-235	-	-	+
104	,		(0382)78-37-55,	+	+	+

	, 18		78-37-73			
105	, 10/1	-	(0382) 723-241, 723-240	+	+	+
106	, 63		097-549-20-36	+	+	+
107	, 7, . 301	-	0472-633-728	+	+	+
108	, 71	-	(0472) 435-389	+	+	+
109	146, . 102	" - "	(0472) 563-478, 500-354, (096) 505-63-63	+	+	+
110	, . 77- , 1		(0462) 601585	+	+	+
111	, 6		(0462) 724872,724949	+	+	+
112	, 105 ()		(0372) 55-48-69,90-13-11	+	+	+
113	, 265		(0372) 58-43-01	+	+	+
114	, 3	" - "	(050) 373-73-71	+	+	+
115	, 5	(-)	(050) 324-43-01	+	+	-

GB

WARRANTY COUPON

When purchasing the product, please require its checking before you; BE SURE that the goods sold to you, are functional and complete and that the warranty coupon is filled in correctly.

This warranty coupon confirms the absence of any defects in the product you purchased and provides for free of charge repair of the product failed through the fault of the manufacturer throughout the period of warranty service and free of charge repair.

Failing the presentation of this coupon, in case of its improper filling in, infringement of factory seals (if any), and also in cases indicated in the warranty obligations, the claims are not accepted, and no warranty service and free of charge repair is made! The warranty coupon is valid only in the original copy with the stamp of trading organization, signature of the seller, date of sale and signature of the buyer.

RU

Faint, illegible text in Russian, possibly bleed-through from the reverse side of the page.

CZ

ZÁRUČNÍ LIST

Při koupi výrobku žádejte o jeho vyzkoušení ve Vaší přítomnosti, PĚŠV DĚSE, že Vám prodaný výrobek je dobře fungující a kompletní a že záruční list je vyplněn správně.

Tento záruční list potvrzuje, že na Vámi koupeném výrobku nejsou žádné vady a zajišťuje bezplatnou opravu nefungujícího přístroje z viny výrobce, během celé záruční doby.

Bez předložení tohoto listu, při jeho nesprávném vyplnění, porušení plomb výrobce (jsou-li na výrobku) a také v případech, které jsou uvedené v záručním listě, nároky se nepřijímají a záruční oprava se neprovádí! Záruční list je platný jenom jako originál s razítkem obchodní organizace, podpisem prodávatele, termínem prodeje a podpisem zákazníka.

UA

Faint, illegible text in Ukrainian, possibly bleed-through from the reverse side of the page.

Saturn®

WARRANTY COUPON

ZÁRU NÍ LIST

SATURN HOME APPLIANCES S.R.O. KON VOVA 141, 13083
PRAHA 3 – ŽIŽKOV, ESKÁ REPUBLIKA, TEL: + 4202/ 67 108 392

Model /

Production number/Výrobní íslo/
/

Date of sell/Termín prodeje/ / ,

Shop stamp/Razítko obchodu/ /

Seller's signature/Podpis prodava e/ /

Buyer's Signature confirming the acquaintance and consent with conditions
of free of charge maintenance service of the product, and absence of the
complaints on appearance and color of the product.

Podpis zákazníka, potvrzující seznámení a souhlas s podmínkami
bezplatného záru ního servisu výrobku, a také neexistence nárok na
vni jšek a barvu výrobku.

Saturn®	Saturn®	Saturn®
Model / /	Model / /	Model / /
Production number / /	Production number / /	Production number / /
Name of the Trade Company / /	Name of the Trade Company / /	Name of the Trade Company / /
Stamp of the Trade Company / /	Stamp of the Trade Company / /	Stamp of the Trade Company / /
Client Address/Phone # / /	Client Address/Phone # / /	Client Address/Phone # / /
Date of Receiving / /	Date of Receiving / /	Date of Receiving / /
Defect / /	Defect / /	Defect / /
Signature, Stamp / /	Signature, Stamp / /	Signature, Stamp / /
COUPON 1	COUPON 2	COUPON 3